

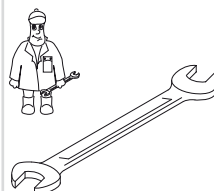

Gebr. Becker GmbH
Hölker Feld 29-31
D-42279 Wuppertal

Wartung
Maintenance
Entretien
Manutenzione
Mantenimiento



	Pos.	Menge Quantity Quantité Quantità Cantidad	Bestell-Nr. Ident No. No. Identification No. Identificazione No. de pedido	Bezeichnung Description Designation Designazione Descripción
DTLF / VTLF 400-500	□	1	549000 22500	Dichtungssatz, Complete set of seals, Jeu de joints, Kit di guarnizioni, Junta Completa
	7	SATZ (KIT)	901373 01010	Schieber, Rotor Vane, Palette, Empujador
	118	1	909540 00000	Filterpatrone, Filter cartridge, Cartouche Filtrante, Cartuccia filtro, Cartucho de filtro
	118	1 ³⁾	909550 00000	Filterpatrone, Filter cartridge, Cartouche Filtrante, Cartuccia filtro, Cartucho de filtro
	507	2 ³⁾	909510 00000	Filterpatrone, Filter cartridge, Cartouche Filtrante, Cartuccia filtro, Cartucho de filtro

³⁾ variantenabhängig / variant-dependent / variante-dependantes / variante-dipendenti / variante-dependientes (SK)



Ersatzteilliste
Spare parts list
Liste de pièces de rechange
Listino pezzi di ricambio
Lista de piezas de recambio
Lista de peças sobresselentes
Reserveonderdelenlijst
Reservedeliste
Reservdelista

Reservedeliste
Varaosaluettelo
Wykaz części zamiennych
Seznam náhradních dílů
Tartalékalkatrész lista
Κατάλογος ανταλλακτικών
Перечень запасных частей
备用零件目录
スペアパーツリスト

DTLF / VTLF 400
DTLF / VTLF 500

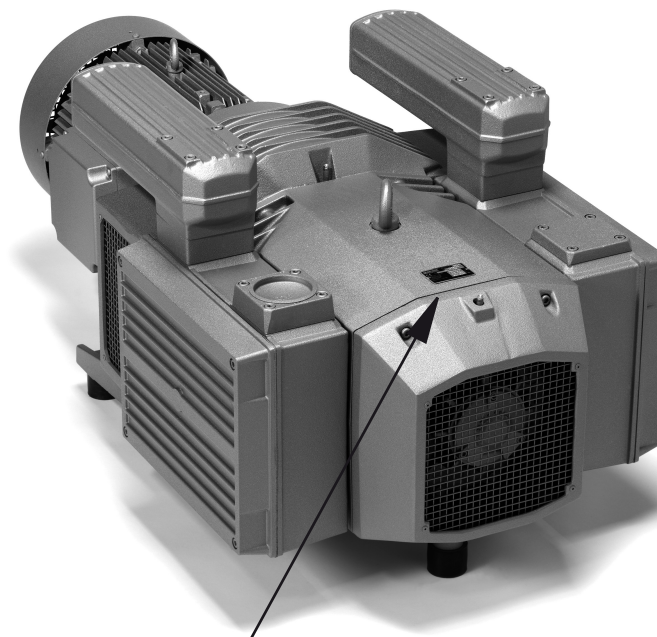

28000022500 02/2009

SERVICE

BECKER
D-42279 Wuppertal
www.becker-international.com

year XXXX

No.

type **VTLF500-XX**

frequency Hz

speed min⁻¹

power required kW

inlet capacity m³/h

max. vacuum mbar

Made in Germany

Index
Option

D Service:

Tel: +49 (0)202 697-171

Fax: +49 (0)202 64 44 74

E-Mail: info@becker-international.com

www.becker-international.com

Index	Pos.	Bestell Nr.	Beschreibung 
DTLF / VTLF 400-500	□	549000 22500	DICHTUNGSSATZ ¹⁾
	1	000100 22500	GEHÄUSE
	5	020000 22500	KOLBEN
	7	901373 01010	KOHLESCHIEBER (SATZ)
	9	947814 00000	PASSFEDER
	10	000700 22500	SEITENDECKEL
	11	000800 22500	SEITENDECKEL
	12	001100 22500	LAGERDECKEL
	13	001000 22500	LAGERDECKEL
	14	001101 22500	LAGERDECKEL
	15	945322 00000	INNENSECHSKANTSCHRAUBE
	16	945319 00000	INNENSECHSKANTSCHRAUBE
	17	945230 00000	SECHSKANTSCHRAUBE
	18	948743 00000	KERBSTIFT
	21	068900 22500	FETT-TRANSPORTRING
	22	945270 00000	WELLENENDSCHRAUBE
	23	968001 60000	DISTANZSCHEIBE
	24	906614 00000	ZYLINDERROLLENLAGER (2x)
	25	906636 00000	WÄLZLAGER
	26	913112 50100	O-RING
	27	911450 00000	ZWISCHENLEGRING 45X55X0,025
	28	911451 00000	ZWISCHENLEGRING 45X55X0,05
	29	911413 60000	ZWISCHENLEGRING 65X85X0,025
	30	911413 70000	ZWISCHENLEGRING 65X85X0,05
	31	917162 00000	AUSGLEICHSCHLEIBE
	32	948265 00000	SICHERUNGSRING
	34	906580 00000	WELLENDICHTRING
	35	911326 00000	DICHTUNGSSCHLAUCH
	37	008100 22200	FETTDROCKROHR
	38	949001 00000	SCHMIERNIPPEL
	40	003100 22500	DICHTUNG
	41	520800 22500	LUFTLEITHAUBE KOMPL.
	47	009600 10100	GUMMIDÄMPFER
	48	945333 00000	INNENSECHSKANTSCHRAUBE
	50	068000 22500	DISTANZSTÜCK
	54	015100 22500	FUSS
	57	945382 00000	INNENSECHSKANTSCHRAUBE
	58	948804 00000	RINGSCHRAUBE
	61	560200 22500	LATERNE KOMPL.
	67	945361 00000	INNENSECHSKANTSCHRAUBE
	68	947507 00000	UNTERLEGSCHLEIBE
	70	544500 22500	KUPPLUNGSHÄLFTE MIT VENTILATOR
	81	040101 22500	FILTERGEHÄUSE
	85	007800 22500	GEWINDEFLENSCH
	89	007900 22500	DICHTUNG
	92	945362 00000	INNENSECHSKANTSCHRAUBE
	94	003000 22500	DICHTUNG
	95	040201 22500	FILTERDECKEL
	96	945338 00000	INNENSECHSKANTSCHRAUBE
	97	950308 00000	UNTERLEGSCHLEIBE
	102	040100 22500	FILTERGEHÄUSE

Index	Pos.	Bestell Nr.	Beschreibung 
DTLF / VTLF 400-500	106	945330 00000	INNENSECHSKANTSCHRAUBE
	107	005600 22500	VERSCHLUSSPLATTE
	110	945373 00000	INNENSECHSKANTSCHRAUBE
	118	909540 00000	FILTERPATRONE C18133 (1x) ²⁾
	119	008900 22500	DICHTUNG
	120	040200 22500	FILTERDECKEL
	123	009000 27000	ANPRESSFEDER
	164	002100 22500	MOTORKUPPLUNG, Ø48MM
	164	002101 22500	MOTORKUPPLUNG, Ø55MM
	164	002102 22500	MOTORKUPPLUNG, Ø60MM
	170	946114 00000	GEWINDESTIFT
	173	902230 00000	KUPPLUNGSSCHLEIBE
	187	500900 22500	MOTORFLANSCH, B5/350
	187	500901 22500	MOTORFLANSCH, B5/400
	187	500902 22500	MOTORFLANSCH, B5/450
	201	947109 00000	SECHSKANTMUTTER
	203	946962 00000	STIFTSCHRAUBE
	204	947509 00000	U-SCHLEIBE
	221	741341 00000	GUMMIPUFFER
	222	946961 00000	STIFTSCHRAUBE
	223	945241 00000	SECHSKANTSCHRAUBE
	421	533700 99620	DRUCKSICHERHEITSENTIL, 1-1.7BAR
	421	533702 99620	ABBLASEVENTIL, 0.15BAR
	421	533703 99620	DRUCKSICHERHEITSENTIL, <1BAR
	425	533701 99620	VAKUUMSICHERHEITSENTIL
	442	007400 22500	SCHALLDÄMPFERGEHÄUSE
	444	945384 00000	INNENSECHSKANTSCHRAUBE, M8X190
	448	945346 00000	INNENSECHSKANTSCHRAUBE, M8X140
	451	007601 16900	SIEBROHR
	452	907700 90000	DÄMPFER
	453	007501 16600	DICHTUNG
	454	007800 16600	ANSCHLUSSFLANSCH
	455	945320 00000	INNENSECHSKANTSCHRAUBE

¹⁾ Dichtungssatz - 54900022500 - Pos.: 26, 35, 40, 89, 94, 119

²⁾ erforderliche Bestellmenge / Wartung

OPTIONAL	VTLF	SK	Sonderausführung - mit Spülkühlung
	VTLF/DTLF	/6	Sonderausführung - Korrosionsschutz
	VTLF	/6-73	" "

Abweichende Positionen zum Standardgerät - siehe Anhang (Zeichnungsrückseite) 

Index	Pos.	Ident No.	Description 
DTLF / VTLF 400-500	□	549000 22500	GASKET SET ¹⁾
	1	000100 22500	PUMP BODY
	5	020000 22500	ROTOR
	7	901373 01010	ROTOR VANES (KIT)
	9	947814 00000	KEY
	10	000700 22500	LID
	11	000800 22500	LID
	12	001100 22500	BEARING COVER
	13	001000 22500	BEARING COVER
	14	001101 22500	BEARING COVER
	15	945322 00000	SOCKET HEAD SCREW
	16	945319 00000	SOCKET HEAD SCREW
	17	945230 00000	HEX-HEAD SCREW
	18	948743 00000	GROOVED PIN
	21	068900 22500	GREASE DISTRIBUTION WASHER
	22	945270 00000	SHAFT END BOLD
	23	968001 60000	DISTANCE DISC
	24	906614 00000	BEARING
	25	906636 00000	BALL BEARING
	26	913112 50100	O-RING
	27	911450 00000	DISTANCE DISC 45X55X0,025
	28	911451 00000	DISTANCE DISC 45X55X0,05
	29	911413 60000	DISTANCE DISC 65X85X0,025
	30	911413 70000	DISTANCE DISC 65X85X0,05
	31	917162 00000	COMPENSATING DISC
	32	948265 00000	LOCKING RING
	34	906580 00000	SHAFT SEALING RING
	35	911326 00000	SEAL
	37	008100 22200	CONDUIT-GREASE
	38	949001 00000	GREASE NIPPLE
	40	003100 22500	GASKET
	41	520800 22500	PROTECTIVE HOOD
	47	009600 10100	DOMPENER
	48	945333 00000	SOCKET HEAD SCREW
	50	068000 22500	SPACING COLLAR
	54	015100 22500	FOOT
	57	945382 00000	SOCKET HEAD SCREW
	58	948804 00000	RING SCREW
	61	560200 22500	CONNECTION FLANGE
	67	945361 00000	SOCKET HEAD SCREW
	68	947507 00000	WASHER
	70	544500 22500	COUPLING WITH FAN
	81	040101 22500	FILTER HOUSING
	85	007800 22500	CONNECTION FLANGE
	89	007900 22500	GASKET
	92	945362 00000	SOCKET HEAD SCREW
	94	003000 22500	GASKET
	95	040201 22500	FILTER COVER
	96	945338 00000	SOCKET HEAD SCREW
	97	950308 00000	WASHER
	102	040100 22500	FILTER HOUSING

Index	Pos.	Ident No.	Description 
DTLF / VTLF 400-500	106	945330 00000	SOCKET HEAD SCREW
	107	005600 22500	COVER
	110	945373 00000	SOCKET HEAD SCREW
	118	909540 00000	FILTER CARTRIDGE C18133 (1x) ²⁾
	119	008900 22500	GASKET
	120	040200 22500	FILTER COVER
	123	009000 27000	LEAF SPRING
	164	002100 22500	COUPLING MOTOR SIDE, Ø48MM
	164	002101 22500	COUPLING MOTOR SIDE, Ø55MM
	164	002102 22500	COUPLING MOTOR SIDE, Ø60MM
	170	946114 00000	THREADED PIN
	173	902230 00000	COUPLING DISC
	187	500900 22500	MOTOR FLANGE, B5/350
	187	500901 22500	MOTOR FLANGE, B5/400
	187	500902 22500	MOTOR FLANGE, B5/450
	201	947109 00000	HEX. NUT
	203	946962 00000	STUD
	204	947509 00000	WASHER
	221	741341 00000	RUBBER BUFFER
	222	946961 00000	STUD
	223	945241 00000	HEX. HEAD SCREW
	421	533700 99620	PRESSURE RELIEVE VALVE, 1-1.7BAR
	421	533702 99620	BLOW-OFF VALVE, 0.15BAR
	421	533703 99620	PRESSURE RELIEVE VALVE, <1BAR
	425	533701 99620	VACUUM RELIEF VALVE
	442	007400 22500	SILENCER HOUSING
	444	945384 00000	SOCKET HEAD SCREW, M8X190
	448	945346 00000	SOCKET HEAD SCREW, M8X140
	451	007601 16900	SIEVE-TUBE
	452	907700 90000	SILENCER SPONGE
	453	007501 16600	GASKET
	454	007800 16600	CONNECTING FLANGE
	455	945320 00000	SOCKET HEAD SCREW

¹⁾ Set of seals - 54900022500 - Pos.: 26, 35, 40, 89, 94, 119

²⁾ necessary order quantity / maintenance

OPTIONAL	VTLF	SK	Special design – extra cooling
	VTLF/DTLF	/6	Special design – corrosion protection
	VTLF	/6-73	Special design – corrosion protection

Items different from standard appliance see appendix (back of drawing) 

Index	Pos.	No. Identification	Designation
DTLF / VTLF 400-500	□	549000 22500	JEU DE JOINTS ¹⁾
	1	000100 22500	CARCASSE
	5	020000 22500	PISTON
	7	901373 01010	PALETTE DE CHARBON (KIT)
	9	947814 00000	CLAVETTE
	10	000700 22500	COUVERCLE
	11	000800 22500	COUVERCLE
	12	001100 22500	COUVERCLE DE ROULEMENT
	13	001000 22500	COUVERCLE DE ROULEMENT
	14	001101 22500	COUVERCLE DE ROULEMENT
	15	945322 00000	VIS HEXAGONALE INTERNE
	16	945319 00000	VIS HEXAGONALE INTERNE
	17	945230 00000	VIS HEXAGONALE
	18	948743 00000	GOUPILLE CANNELEE
	21	068900 22500	BAGUE DE TRANSPORT DE GRAISSE
	22	945270 00000	VIS BOUT D'ARBRE
	23	968001 60000	DISQUE AJUSTAGE
	24	906614 00000	ROULEMENT
	25	906636 00000	ROULEMENT A BILLES
	26	913112 50100	ANNEAU-O
	27	911450 00000	BAGUE 45X55X0,025
	28	911451 00000	BAGUE 45X55X0,05
	29	911413 60000	BAGUE 65X85X0.025
	30	911413 70000	BAGUE 65X85X0.05
	31	917162 00000	DISQUE DE COMPENSATION
	32	948265 00000	BAGUE DE SURETE
	34	906580 00000	BAGUE D'ETANCHEITE P.L'AXE
	35	911326 00000	JOINT
	37	008100 22200	TUYEAU DE GRAISSAGE
	38	949001 00000	GRAISSEUR
	40	003100 22500	JOINT
	41	520800 22500	CARTER PROTECTEUR
	47	009600 10100	AMORTISSEUR
	48	945333 00000	VIS HEXAGONALE INTERNE
	50	068000 22500	DONILLE D'ECARMENT
	54	015100 22500	PIED
	57	945382 00000	VIS HEXAGONALE INTERNE
	58	948804 00000	PITON
	61	560200 22500	BRIDE DE RACCORDEMENT
	67	945361 00000	VIS HEXAGONALE INTERNE
	68	947507 00000	RONDELLE
	70	544500 22500	ACCOUPLLEMENT AVEC VENTILATEUR
	81	040101 22500	BOITE POUR FILTRE
	85	007800 22500	BRIDE DE RACCORDEMENT
	89	007900 22500	JOINT
	92	945362 00000	VIS HEXAGONALE INTERNE
	94	003000 22500	JOINT
	95	040201 22500	COUVERCLE DU FILTRE
	96	945338 00000	VIS HEXAGONALE INTERNE
	97	950308 00000	RONDELLE
	102	040100 22500	BOITE POUR FILTRE

Index	Pos.	No. Identification	Designation
DTLF / VTLF 400-500	106	945330 00000	VIS HEXAGONALE INTERNE
	107	005600 22500	COUVERCLE DE FERMETURE
	110	945373 00000	VIS HEXAGONALE INTERNE
	118	909540 00000	CARTOUCHE FILTRANTE C18133 (1x) ²⁾
	119	008900 22500	JOINT
	120	040200 22500	COUVERCLE DU FILTRE
	123	009000 27000	RESSORT-JAME
	164	002100 22500	ACCOUPLLEMENT MOTEUR, Ø48MM
	164	002101 22500	ACCOUPLLEMENT MOTEUR, Ø55MM
	164	002102 22500	ACCOUPLLEMENT MOTEUR, Ø60MM
	170	946114 00000	GOUPILLE FILETEE
	173	902230 00000	DISQUE D'ACCOUPLLEMENT
	187	500900 22500	BRIDE MOTEUR, B5/350
	187	500901 22500	BRIDE MOTEUR, B5/400
	187	500902 22500	BRIDE MOTEUR, B5/450
	201	947109 00000	ECROU A 6 PANS
	203	946962 00000	TOURILLON
	204	947509 00000	RONDELLE
	221	741341 00000	AMORTISSEUR EN CAOUTCHOUC
	222	946961 00000	PRISONNIER
	223	945241 00000	VIS HEXAGONALE
	421	533700 99620	SOUPAPE DE SURERE PRESSION, 1-1.7BAR
	421	533702 99620	SILENCIEUX, 0.15BAR
	421	533703 99620	SOUPAPE DE SURERE PRESSION, <1BAR
	425	533701 99620	SOUPAPE DE SURETE VIDE
	442	007400 22500	CARCASSE SILENCIEUX
	444	945384 00000	VIS HEXAGONALE INTERNE, M8X190
	448	945346 00000	VIS HEXAGONALE INTERNE, M8X140
	451	007601 16900	TUYAU-TAMIS
	452	907700 90000	MOUSSE POUR SILENCIEUX
	453	007501 16600	JOINT
	454	007800 16600	BRIDE DE RACCORDEMENT
	455	945320 00000	VIS HEXAGONALE INTERNE

¹⁾ Jeu de joints - 54900022500 - Pos.: 26, 35, 40, 89, 94, 119

²⁾ quantité nécessaire / entretien

EN OPTION	VTLF	SK	Fabrication spéciale – refrigeration supplémentaire
	VTLF/DTLF	/6	Fabrication spéciale – protection contre la corrosion
	VTLF	/6-73	“ “ “ “
Articles divergents vis-à-vis de l'appareil standard, voir annexe (dos du dessin / du plan)			

Index	Pos.	No. Identificazione	Designazione 
DTLF / VTFL 400-500	□	549000 22500	KIT GUARNIZIONI ¹⁾
	1	000100 22500	CARASSA
	5	020000 22500	ROTORE
	7	901373 01010	PALETTE (KIT)
	9	947814 00000	CHIAVETTA
	10	000700 22500	COPERCHIO
	11	000800 22500	COPERCHIO
	12	001100 22500	COPERCHIO CUSCINETTO
	13	001000 22500	COPERCHIO CUSCINETTO
	14	001101 22500	COPERCHIO CUSCINETTO
	15	945322 00000	VITE ESAGONALE INTERNA
	16	945319 00000	VITE ESAGONALE INTERNA
	17	945230 00000	VITE ESAGONALE
	18	948743 00000	SPINA INTAGLIATA
	21	068900 22500	ANELLO INGRASSAGGIO
	22	945270 00000	VITE DI CHIUSURA ALBERO
	23	968001 60000	DISCO DISTANZA
	24	906614 00000	CUSCINETTO
	25	906636 00000	CUSCINETTO A SFERA
	26	913112 50100	ANELLO-O
	27	911450 00000	DISCO GIUOCO 45X55X0,025
	28	911451 00000	DISCO GIUOCO 45X55X0,05
	29	911413 60000	DISCO GIUOCO 65X85X0,025
	30	911413 70000	DISCO GIUOCO 65X85X0,05
	31	917162 00000	DISCO COMPENSATORE
	32	948265 00000	ANELLO DI SICUREZZA
	34	906580 00000	GUARNIZIONE PER L'ALBERO
	35	911326 00000	GUARNIZIONE
	37	008100 22200	TUBETTO D'INGRASSAGGIO
	38	949001 00000	RACCORDO DI LUBRIFICAZIONE
	40	003100 22500	GUARNIZIONE
	41	520800 22500	CARTER DI PROTEZIONE
	47	009600 10100	AMMORTIZZATORE
	48	945333 00000	VITE ESAGONALE INTERNA
	50	068000 22500	BOCCOLA DISTANZIATRICE
	54	015100 22500	PIEDE
	57	945382 00000	VITE ESAGONALE INTERNA
	58	948804 00000	GANCIO
	61	560200 22500	FLANGIA DI RACCORDE
	67	945361 00000	VITE ESAGONALE INTERNA
	68	947507 00000	RONDELLA
	70	544500 22500	GIUNTO CON VENTILATORE
	81	040101 22500	CONTENITORE FILTRO
	85	007800 22500	FLANGIA DI RACCORDE
	89	007900 22500	GUARNIZIONE
	92	945362 00000	VITE ESAGONALE INTERNA
	94	003000 22500	GUARNIZIONE
	95	040201 22500	COPERCHIO FILTRO
	96	945338 00000	VITE ESAGONALE INTERNA
	97	950308 00000	RONDELLA
	102	040100 22500	CONTENITORE FILTRO

Index	Pos.	No. Identificazione	Designazione 
DTLF / VTFL 400-500	106	945330 00000	VITE ESAGONALE INTERNA
	107	005600 22500	COPERCHIO
	110	945373 00000	VITE ESAGONALE INTERNA
	118	909540 00000	CARTUCCIA FILTRO C18133 (1x) ²⁾
	119	008900 22500	GUARNIZIONI
	120	040200 22500	COPERCHIO FILTRO
	123	009000 27000	MOLLA
	164	002100 22500	GIUNTO MOTORE, Ø48MM
	164	002101 22500	GIUNTO MOTORE, Ø55MM
	164	002102 22500	GIUNTO MOTORE, Ø60MM
	170	946114 00000	SPINA FILETTATURA
	173	902230 00000	DISCO GIUNTO
	187	500900 22500	FLANGIA MOTORE, B5/350
	187	500901 22500	FLANGIA MOTORE, B5/400
	187	500902 22500	FLANGIA MOTORE, B5/450
	201	947109 00000	DADO ESAGONALE
	203	946962 00000	VITE PRIGIONIERA
	204	947509 00000	RONDELLA PIANA
	221	741341 00000	AMMORTIZZATORE IN GOMMA
	222	946961 00000	L'ASTA A VITE
	223	945241 00000	VITE ESAGONALE
	421	533700 99620	VALVOLA SICUREZZA PRESSIONE, 1-1.7BAR
	421	533702 99620	SILENZIATORE, 0.15BAR
	421	533703 99620	VALVOLA SICUREZZA PRESSIONE, <1BAR
	425	533701 99620	VALVOLA SICUREZZA VUOTO
	442	007400 22500	CARASSA SILEZIATORE
	444	945384 00000	VITE ESAGONALE INTERNA, M8X190
	448	945346 00000	VITE ESAGONALE INTERNA, M8X140
	451	007601 16900	TUBO-CRIVELLO
	452	907700 90000	MATERIALE PER SILENZIATORE
	453	007501 16600	GUARNIZIONE
	454	007800 16600	FLANGIA DI RACCORDO
	455	945320 00000	VITE ESAGONALE INTERNA

¹⁾ Serie di guarnizione - 54900022500 - Pos.: 26, 35, 40, 89, 94, 119

²⁾ quantità di ordinazione necessari / manutenzione

OPZIONALE	VTFL	SK	Modello speciale - refrigerazione supplementari
	VTFL/DTLF	/6	Modello speciale - protezione anti-corrosione
	VTFL	/6-73	" " " " " "

Vedere allegato (retro del disegno) per le posizioni divergenti dall'apparecchio standard 

Index	Pos.	No. De pedido	Descripción	
DTLF / VTLF 400-500	□	549000 22500	JUEGO DE JUNTA ¹⁾	
	1	000100 22500	CARCASA	
	5	020000 22500	ÉMBOLO	
	7	901373 01010	DESPLAZADOR DE CARBÓN (KIT)	
	9	947814 00000	LENGÜETA DE AJUSTE	
	10	000700 22500	TAPA LATERAL	
	11	000800 22500	TAPA LATERAL	
	12	001100 22500	TAPA DE COJINETE	
	13	001000 22500	TAPA DE COJINETE	
	14	001101 22500	TAPA DE COJINETE	
	15	945322 00000	TORNILLO HEXAGONAL INTERIOR	
	16	945319 00000	TORNILLO HEXAGONAL INTERIOR	
	17	945230 00000	TORNILLO DE CABEZA HEXAGONAL	
	18	948743 00000	PASADOR ENTALLADO	
	21	068900 22500	ANILLO DE TRANSPORTE DE GRASA	
	22	945270 00000	TORNILLO TERMINAL DE ÁRBOL	
	23	968001 60000	ARANDELA DISTANCIADORA	
	24	906614 00000	COJINETE DE RODILLOS CILÍNDRICO NU2211 EC	
	25	906636 00000	COJINETE DE RODAMIENTO 3209/C 3	
	26	913112 50100	JUNTA TÓRICA	
	27	911450 00000	ANILLO DE COLOCACIÓN INTERMEDIO 45X55X0.025	
	28	911451 00000	ANILLO DE COLOCACIÓN INTERMEDIO 45X55X0.05	
	29	911413 60000	ANILLO DE COLOCACIÓN INTERMEDIO 65X85X0.025	
	30	911413 70000	ANILLO DE COLOCACIÓN INTERMEDIO 65X85X0.05	
	31	917162 00000	ARANDELA DE COMPENSACIÓN	
	32	948265 00000	ANILLO DE ASEGURAMIENTO	
	34	906580 00000	ANILLO DE JUNTA DE ÁRBOL	
	35	911326 00000	MANGUERA DE JUNTA	
	37	008100 22200	TUBO DE PRESIÓN DE GRASA	
	38	949001 00000	BOQUILLA DE LUBRICACIÓN	
	40	003100 22500	JUNTA	
	41	520800 22500	CAPERUZA GUÍA DE AIRE COMPLETA.	
	47	009600 10100	AMORTIGUADOR DE GOMA	
	48	945333 00000	TORNILLO HEXAGONAL INTERIOR	
	50	068000 22500	PIEZA DISTANCIADORA	
	54	015100 22500	PIE	
	57	945382 00000	TORNILLO HEXAGONAL INTERIOR	
	58	948804 00000	TORNILLO DE CÁNCAMO	
	61	560200 22500	FAROL COMPLETO	
	67	945361 00000	TORNILLO HEXAGONAL INTERIOR	
	68	947507 00000	ARANDELA	
	70	544500 22500	MITAD DE ACOPLAMIENTO CON VENTILADOR	
	81	040101 22500	CARCASA DE FILTRO	
	85	007800 22500	BRIDA ROSCADA	
	89	007900 22500	JUNTA	
	92	945362 00000	TORNILLO HEXAGONAL INTERIOR	
	94	003000 22500	JUNTA	
	95	040201 22500	TAPA DE FILTRO	
	96	945338 00000	TORNILLO HEXAGONAL INTERIOR	
	97	950308 00000	ARANDELA	
	102	040100 22500	CARCASA DE FILTRO	

Index	Pos.	No. De pedido	Descripción	
	106	945330 00000	TORNILLO HEXAGONAL INTERIOR	
	107	005600 22500	PLACA DE CIERRE	
	110	945373 00000	TORNILLO HEXAGONAL INTERIOR	
	118	909540 00000	CARTUCHO C18133 (1x) ²⁾	
	119	008900 22500	JUNTA DE GOMA	
	120	040200 22500	TAPA DE FILTRO	
	123	009000 27000	MUELLE DE PRESIÓN	
	164	002100 22500	MITAD DE MOTOR DE ACOPLAMIENTO, Ø48MM	
	164	002101 22500	MITAD DE MOTOR DE ACOPLAMIENTO, Ø55MM	
	164	002102 22500	MITAD DE MOTOR DE ACOPLAMIENTO, Ø60MM	
	170	946114 00000	VARILLA ROSCADA	
	173	902230 00000	DISCO DE ACOPLAMIENTO	
	187	500900 22500	BRIDA DE MOTOR, B5/350	
	187	500901 22500	BRIDA DE MOTOR, B5/400	
	187	500902 22500	BRIDA DE MOTOR, B5/450	
	201	947109 00000	TUERCA HEXAGONAL	
	203	946962 00000	ESPÁRRAGO	
	204	947509 00000	ARANDELA	
	221	741341 00000	AMORTIGUADOR DE GOMA	
	222	946961 00000	ESPÁRRAGO	
	223	945241 00000	TORNILLO DE CABEZA HEXAGONAL	
	421	533700 99620	VÁLVULA DE SEGURIDAD DE PRESIÓN, 1-1.7BAR	
	421	533702 99620	VÁLVULA DE BARRIDO, 0.15BAR	
	421	533703 99620	VÁLVULA DE SEGURIDAD DE PRESIÓN, <1BAR	
	425	533701 99620	VÁLVULA ASEGURADORA DE VACÍO	
	442	007400 22500	CARCASA DE SILENCIADOR	
	444	945384 00000	TORNILLO HEXAGONAL INTERIOR, M8X190	
	448	945346 00000	TORNILLO HEXAGONAL INTERIOR, M8X140	
	451	007601 16900	TUBO DE CRIBA	
	452	907700 90000	AMORTIGUADOR	
	453	007501 16600	JUNTA	
	454	007800 16600	BRIDA DE EMPALME	
	455	945320 00000	TORNILLO HEXAGONAL INTERIOR	

DTLF / VTLF 400-500

¹⁾ Junta completa - 54900022500 - Pos.: 26, 35, 40, 89, 94, 119
²⁾ cantidad necesario / mantenimiento

OPCIONAL

VTLF	SK	Versión especial – refrigeración adicional
VTLF/DTLF	/6	Versión especial – protección contra la corrosión
VTLF	/6-73	“ “ “ “ “ “

Para posiciones que derivan del aparato standard véase apéndice (lado trasero del plano) 

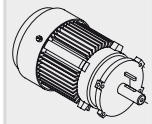

SERVICE ?

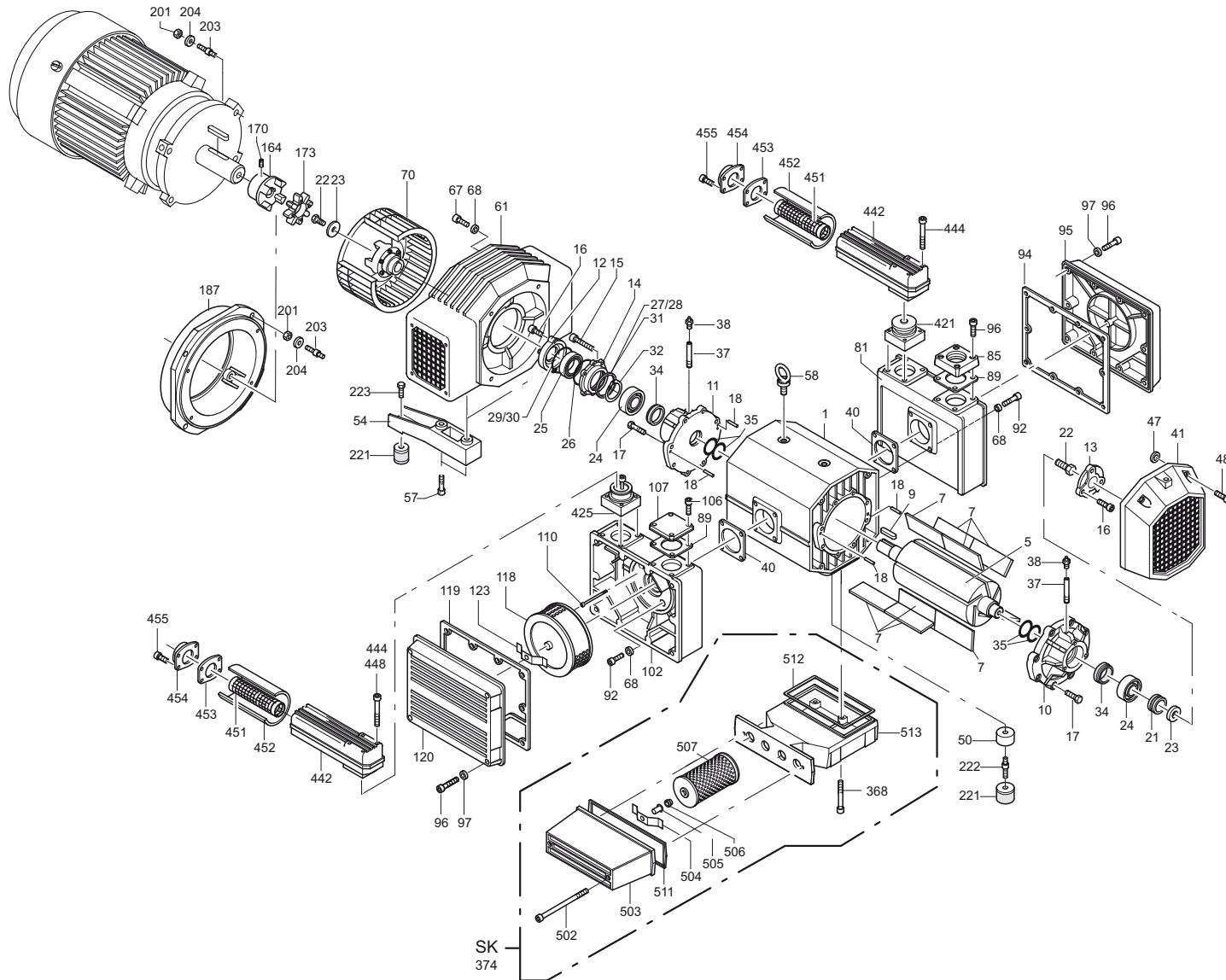
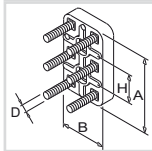
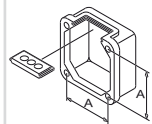
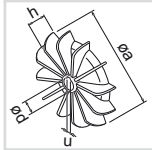
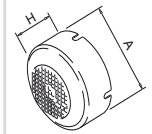





standard

DTLF 400
DTLF 500

VTLF 400
VTLF 500

optional
en option
opcionale
opcional

optional en option optionale opcional 	Variante(n) Modifications Variantes	Pos ³⁾	Bestell Nr. / Ident No. / No. Identification / No. Identificazione / No. De pedido		Beschreibung / Description / Designation / Designazione / Descripcion	
						
VTLF 400/XX VTLF 500/XX DTLF 500/XX	VTLF 400 SK	1	000101 22500	000100-22500	GEHÄUSE / PUMP BODY / CORP DE POMPE / CARCASSA / CARCASA INNENSECHSKANTSCHRAUBE / SOCKET HEAD SCREW / VIS HEXAGONALE INTERNE / VITE ESAGONALE INTERNA / TORNILLO HEXAGONAL INTERIOR KÜHLER, KOMPLETT / COOLER, COMPLETE / REFRIGERISSEUR, COMPLET / RAFFREDDATORE, COMPLETE / REFRIGERADOR COMPLETO INNENSECHSKANTSCHRAUBE / SOCKET HEAD SCREW / VIS HEXAGONALE INTERNE / VITE ESAGONALE INTERNA / TORNILLO HEXAGONAL INTERIOR FILTERDECKEL / FILTER COVER / COUVERCLE DU FILTRE / COPERCHIO FILTRO / TAPA DE FILTRO FEDER / SPRING / RESSORT / MOLLA / MUELLE KERBNAGEL / SLOTTED PIN / GOUPILLE A ENCOCHE / PERNO / CLAVO ESTRIADO STOPFEN / PLUG / BOUCHON / TAPPO / TAPÓN FILTERPATRONE / FILTER CARTRIDGE / CARTOUCHE FILTRANTE / CARTUCCIA FILTRO / CARTUCHO DE FILTRO DICHTUNG / GASKET / JOINT / GUARNIZIONE / JUNTA DICHTUNG / GASKET / JOINT / GUARNIZIONE / JUNTA FILTERGEHÄUSE / FILTER HOUSING / BOITE POUR FILTRE / CONTENITORE FILTRO / CARCASA DE FILTRO	
	VTLF 500 SK	368	945341 00000			
		374	560500 22200			
		502	945347 00000			
		503	040202 22200			
		504	009000 27000			
		505	948705 00000			
		506	912832 00000			
		507	909510 00000			
		511	008901 22200			
		512	008902 22200			
		513	040102 22200			
		VTLF 400/6	1	000111 22500		000100-22500
		VTLF 500/6	5	020011 22500		020000-22500
		DTLF 500/6	10	000711 22500		000700-22500
		11	000811 22500	000800-22500		
	 VTLF 400/6-73 VTLF 500/6-73	118	909550 00000	909540-00000		

³⁾ variantenabhängige Bauteile / variant-dependent components / composants variante-dependantes / componenti variante-dispendenti / componentes variante-dependientes